

x8 50 1 CARGO

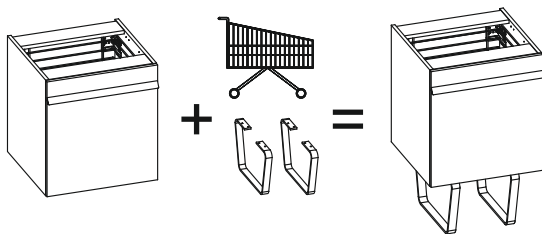
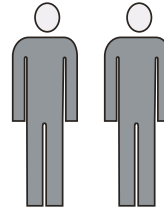
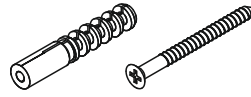
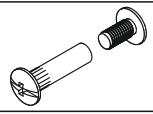
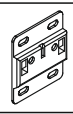
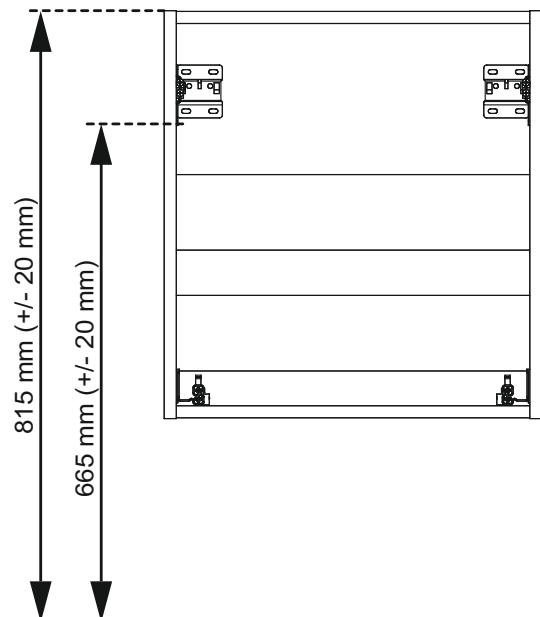
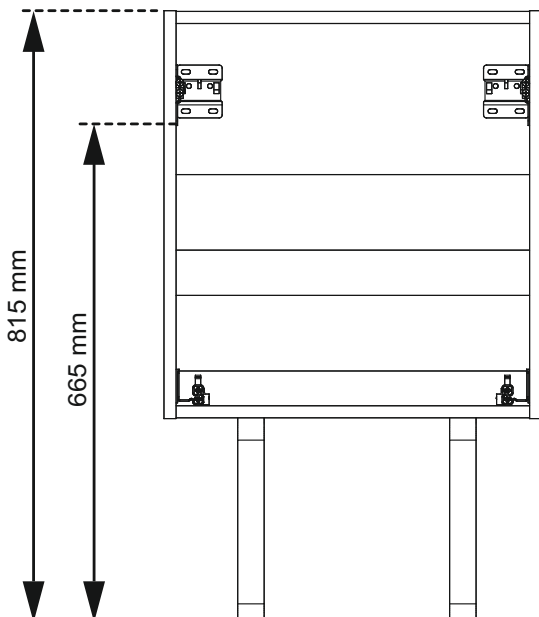

X

x 1
P15

x 2

01.

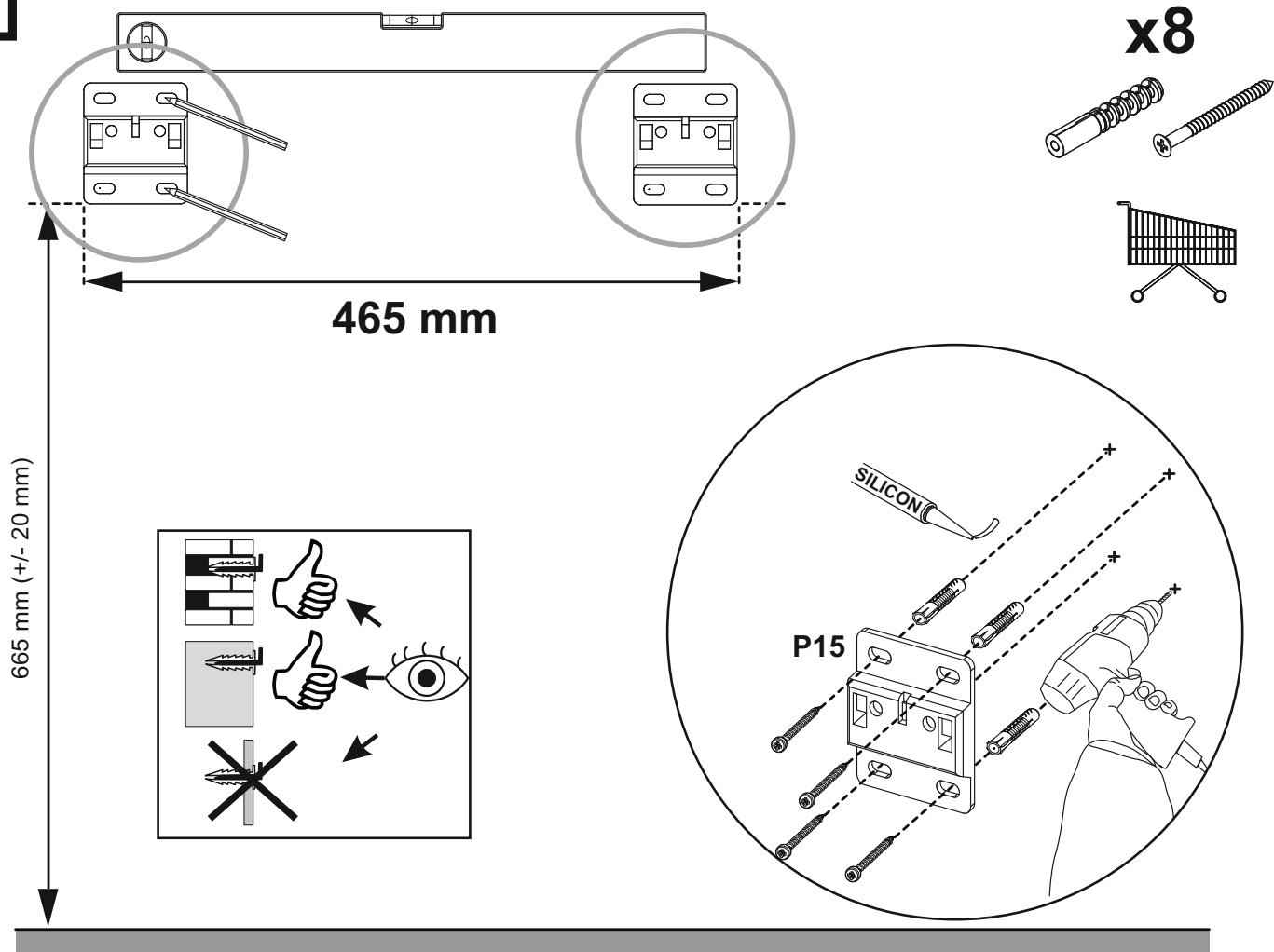

02.



03.

