

Wymiary i rysunki wymiarowe

Flange PN10 DN65

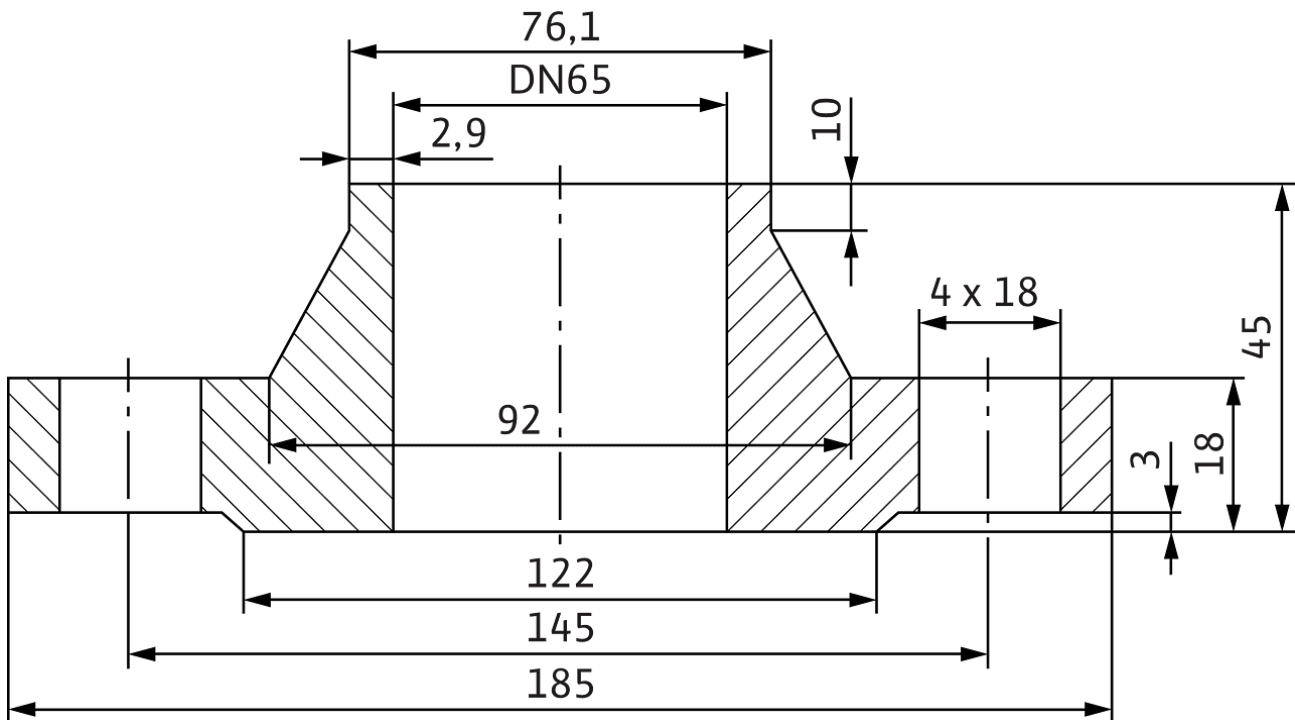

Specyfikacja ofertowa

Two steel weld neck flanges in accordance with DIN-EN 1092-1 type 11 with a neck for welding to pipes as well as gaskets and screws/nuts for the flange connections.

Depending on the configuration of the operating pressure of an installation, the appropriate counter flange must be selected for the operating pressure.

Scope of delivery

- > 2 weld neck flanges
- > 2 gaskets
- > Screws/nuts (number and size based on flange version)

Dane techniczne

Przyłącze wejścia	DN 65
Przyłącze wyjścia	DN 65
Ciśnienie nominalne	PN 10
Materiał	Stal nierdzewna
Masa	7,3 kg
Produkt	Wilo
Nr art.	2105583